

# TOPAKUSTIK® type ARIA - 28/4M

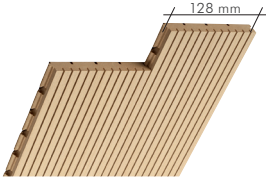

## Planks

Thanks to the precise tongue and groove connection, TOPAKUSTIK planks result in a monolithic surface with a joint-free appearance, because the connecting joint matches the dimension of the grooves. The planks allow simple and flexible assembly. They can be installed by stapling to a wood batten or clamping to a T-bar with TOPAKUSTIK clips.

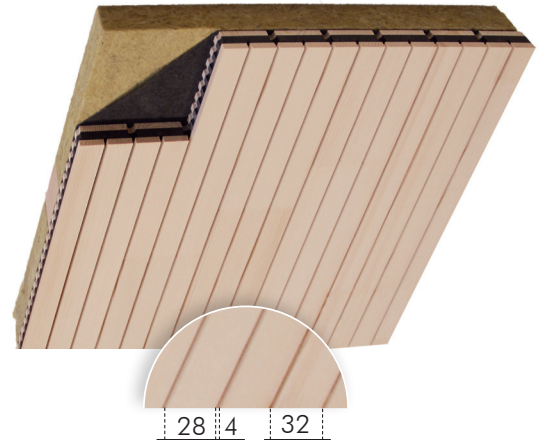

28 4 32

28 mm flat area - 4 mm groove  
32 mm center to center spacing

Class C Fire Rated			Class A Fire Rated		
Paint 16 mm (0.63")	Wood Veneer 17 mm (0.67")	Melamine 16 mm (0.63")	Paint 16 mm (0.63")	Wood Veneer 17 mm (0.67")	Melamine 16 mm (0.63")
Standard					
2780 x 128 (109.45" x 5.04")	2780 x 128 (109.45" x 5.04")	2780 x 128 (109.45" x 5.04")	2780 x 128 (109.45" x 5.04")	2780 x 128 (109.45" x 5.04")	2780 x 128 (109.45" x 5.04")
	3640 x 128 (143.3" x 5.04")			3640 x 128 (143.3" x 5.04")	
4080 x 128 (160.63" x 5.04")		4080 x 128 (160.63" x 5.04")	4080 x 128 (160.63" x 5.04")		4080 x 128 (160.63" x 5.04")

custom lengths are also available - waste charges may apply

## Finishing Options

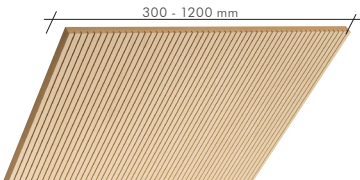
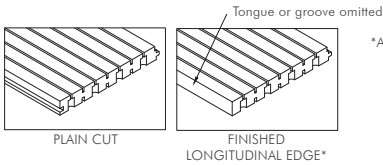
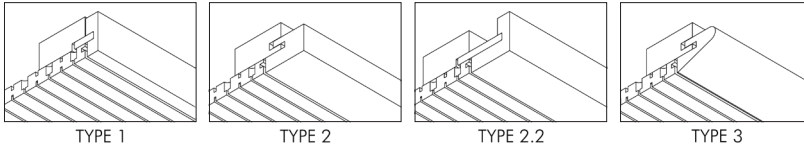

## Panels

Panels are used for removable or fixed ceilings and walls and will have visible joints. Panels can be provided with a number of different edge conditions and are also suited for cabinet fronts and room dividers. They can also be provided with ungrooved borders or grooves running off the edge.

Class C Fire Rated			Class A Fire Rated		
Paint 16 mm (0.63")	Wood Veneer 17 mm (0.67")	Melamine 17 mm (0.67")	Paint 16 mm (0.63")	Wood Veneer 17 mm (0.67")	Melamine 16 mm (0.63")
max.					
3640 x 1216 (143.3" x 47.875")	3640 x 1216 (143.3" x 47.875")	3640 x 1216 (143.3" x 47.875")	3640 x 1216 (143.3" x 47.875")	3640 x 1216 (143.3" x 47.875")	3640 x 1216 (143.3" x 47.875")
ideal = means optimal use of MDF core - custom lengths are also available					
2040 x 992 / 640 (80.3" x 39" / 25.2")	2040 x 992 / 640 (80.3" x 39" / 25.2")	2040 x 992 (80.3" x 39")	2040 x 992 (80.3" x 39")	2040 x 992 (80.3" x 39")	2040 x 992 (80.3" x 39")
2780 x 992 / 640 (109.45" x 39" / 25.2")	2780 x 992 / 640 (109.45" x 39" / 25.2")	2780 x 992 (109.45" x 39")	2780 x 992 (109.45" x 39")	2780 x 992 (109.45" x 39")	2780 x 992 (109.45" x 39")
3640 x 640 (143.3" x 25.2")	3640 x 640 (143.3" x 25.2")			3640 x 640 (143.3" x 25.2")	

## Finishing Options

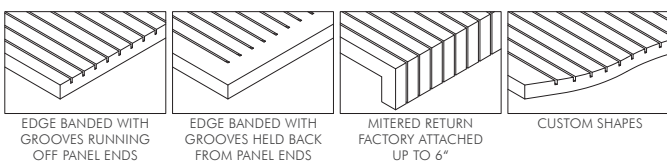
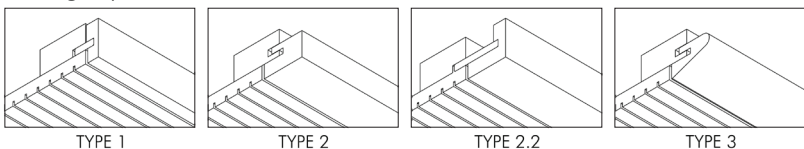

## Sound Absorption Values

28/4 Aria 9.3%

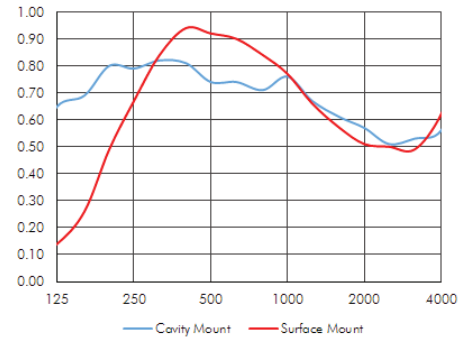

	125 Hz	250 Hz	500 Hz	1000 Hz	2000 Hz	4000 Hz	NRC
1" Insulation 6" Cavity Behind	0.61	0.80	0.76	0.71	0.56	0.62	0.70
1" Insulation Surface Mount	0.17	0.67	0.92	0.76	0.53	0.66	0.70

## Corner Trims and Finishing

Types 21, 22, 23 & 26 are anodized aluminum

